

Item CODE **PLP-1153**

Item Name **Dining table - D1977**

Finish

OVERALL DIMENSION:

Length (W)	Depth (D)	Height (H)
82"	42"	30"

PACKING DIMENSION:

Length (W)	Depth (D)	Height (H)
1710	1160	210

MATERIAL SPECIFICATIONS

Drawn by: **Mr. Antony Tran**

Revised by:

Approved by:

Date: **November 16, 2021**

REVISION HISTORY

No.	REMARKS :	By:	Date
1		---	

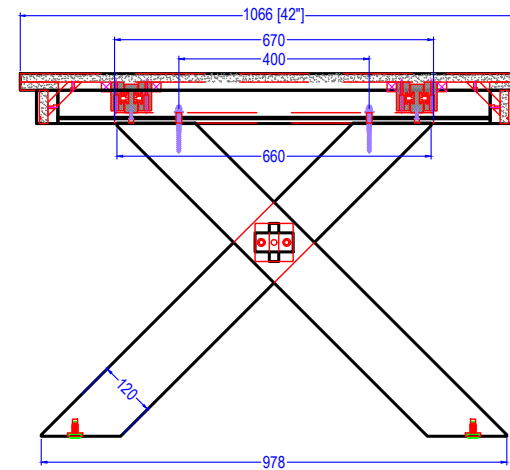
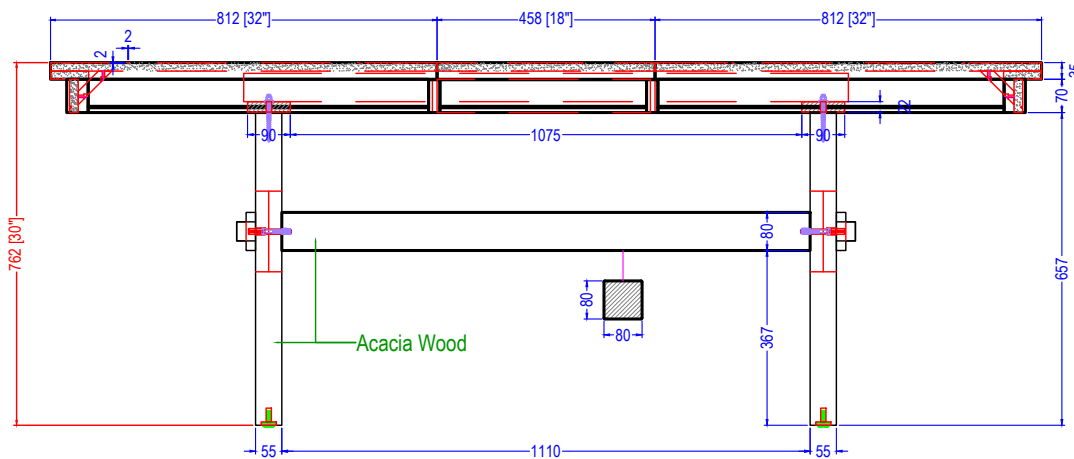
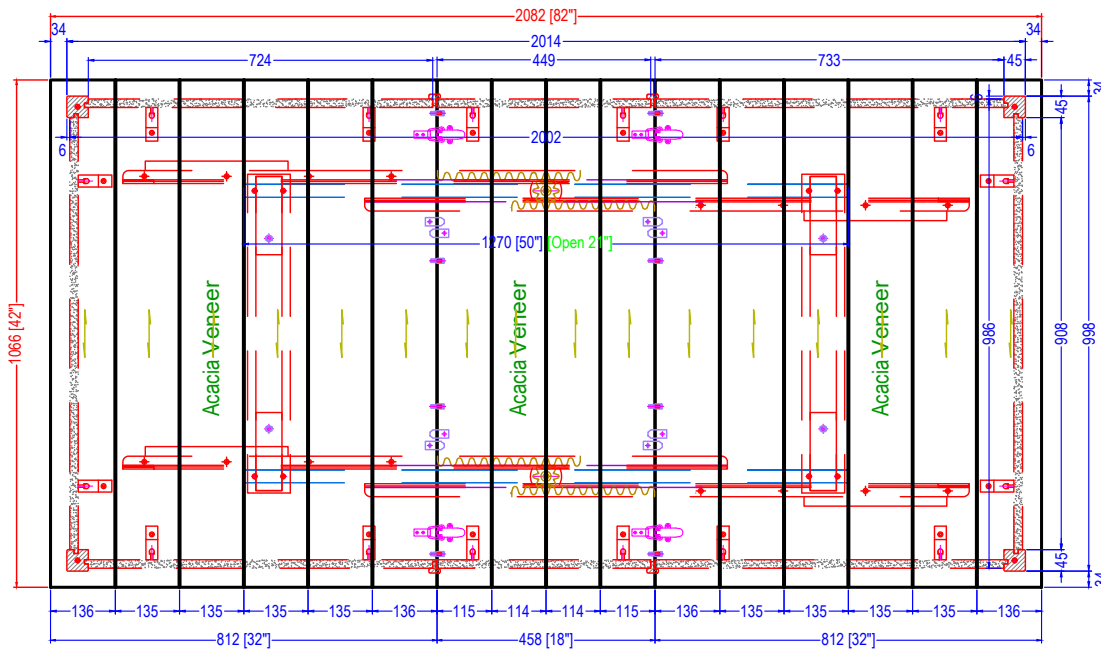
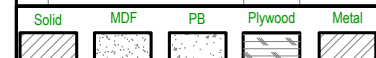

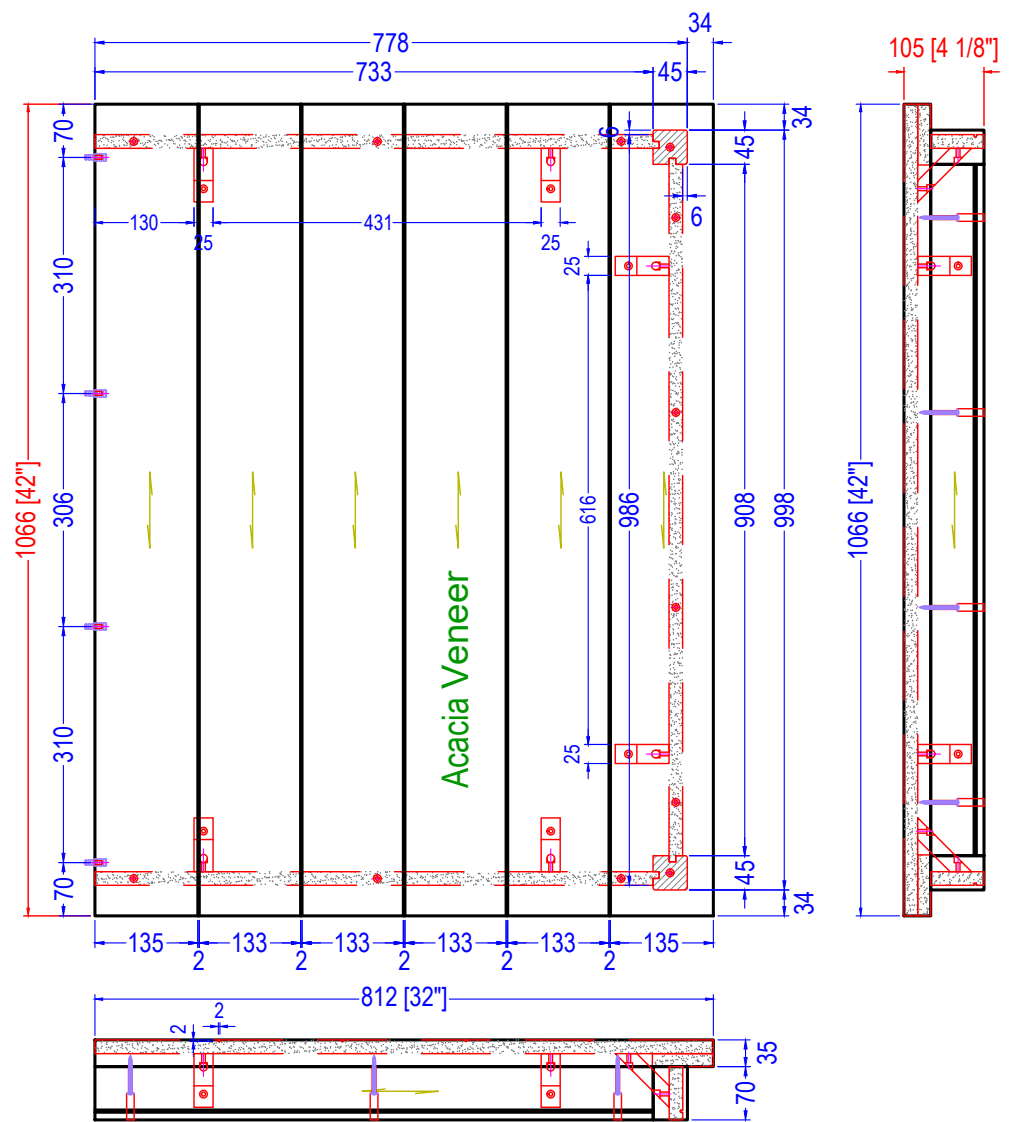
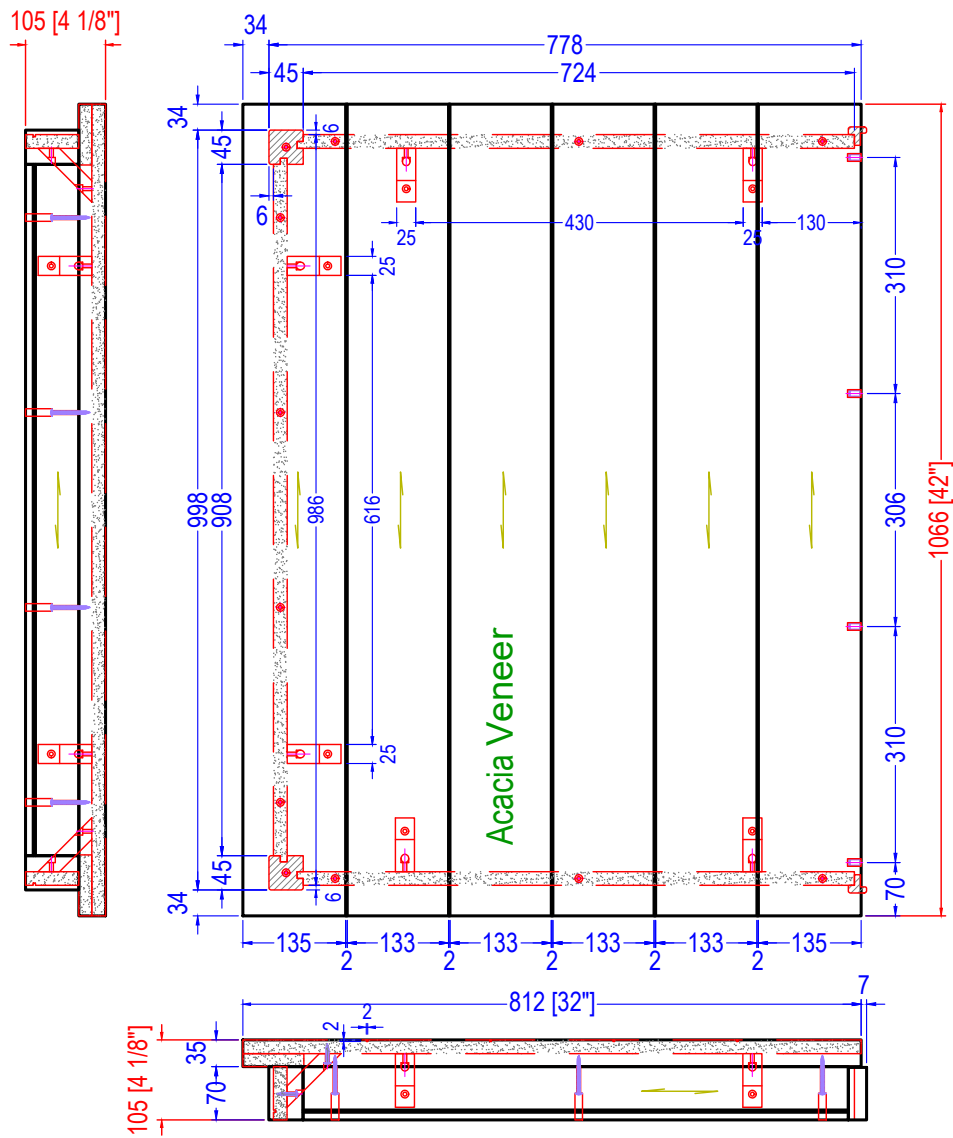

SPECIFICATIONS	L (mm)	W (mm)	T (mm)	Material name:
Finish Dimension	812	1066	105	Drawn by: Mr. Antony Tran Drawn date: November 16, 2021 Page: 1/13
WoodFurniture	Item CODE:	PLP-1153		Description: Top left
	Item Name:	Dining table		Comp. ID: A1
	Finish:	---		Qty/unit: 01

SPECIFICATIONS	L (mm)	W (mm)	T (mm)	Material name:
Finish Dimension	812	1066	105	Drawn by: Mr. Antony Tran Drawn date: November 16, 2021 Page: 1/13
WoodFurniture	Item CODE:	PLP-1153		Description: Top right
	Item Name:	Dining table		Comp. ID: A2
	Finish:	---		Qty/unit: 01

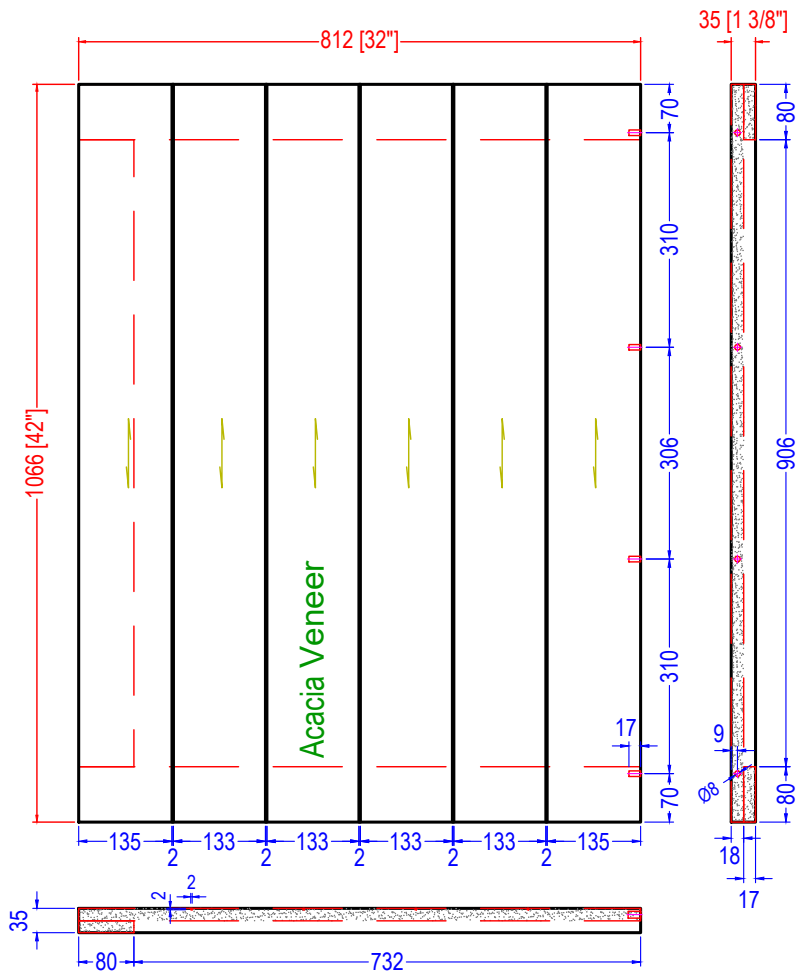

(T&P)

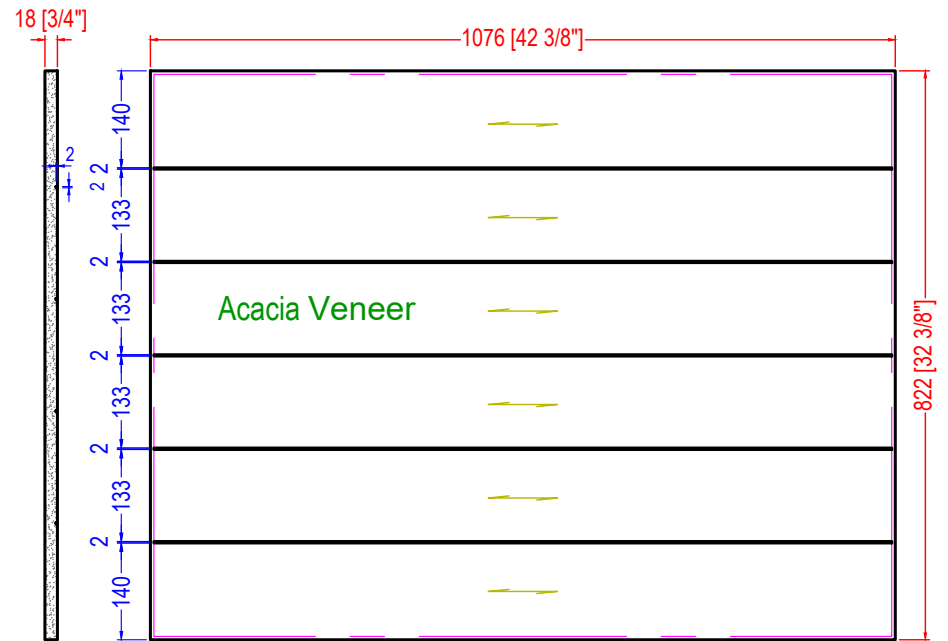

Description	Top panel	SPECIFICATIONS	L (mm)	W (mm)	T (mm)	Material name:
Comp. ID	A1,2S1F1	Finish Dimension	1076	822	18	MDF + Acacia veneer / local veneer
Qty/unit	02	Raw Dimension	1086	832	17	

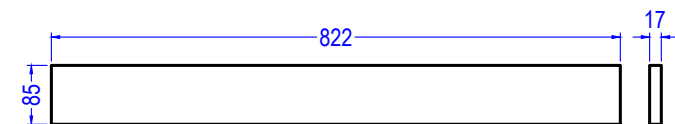

Comp. ID	A1,2S1F2	Qty/unit	04	Description	Support top 1	Material name:	MDF
----------	-----------------	----------	-----------	-------------	---------------	----------------	-----

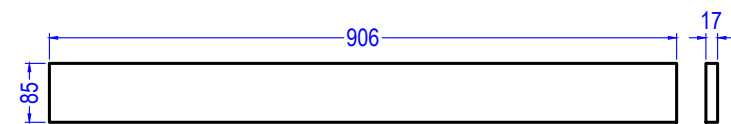

Comp. ID	A1,2S1F3	Qty/unit	02	Description	Support top 2	Material name:	MDF
----------	-----------------	----------	-----------	-------------	---------------	----------------	-----

SPECIFICATIONS	L (mm)	W (mm)	T (mm)	Material name:	MDF + Acacia veneer / local veneer
Finish Dimension	812	1066	35	Drawn by:	Mr. Antony Tran
				Drawn date:	November 16, 2021
				Page:	1/13
WoodFurniture	Item CODE:	PLP-1153	Description	Frame Top panel	
	Item Name:	Dining table	Comp. ID	A1,2S1F	
	Finish	---	Qty/unit	02	

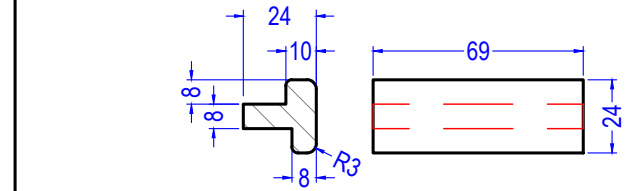
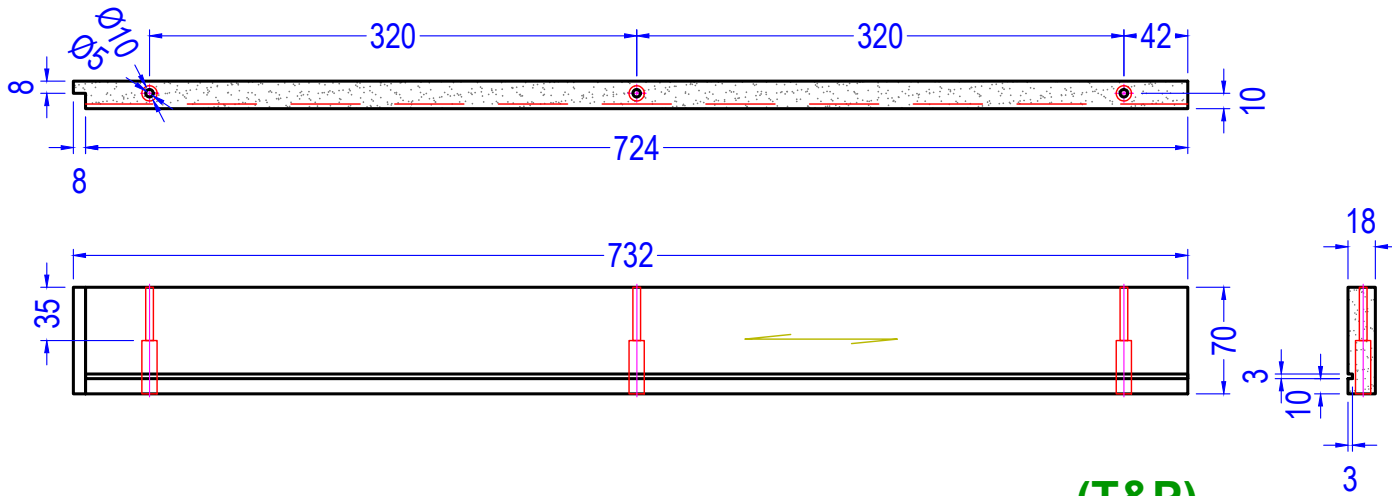

(T&P)

Material name: MDF + Acacia veneer / local veneer					
Description	Support Rail 1	SPECIFICATIONS	L (mm)	W (mm)	T (mm)
Comp. ID	A1S2	Finish Dimension	732	70	18
Qty/unit	02	Raw Dimension	742	80	17

Material name: Rubber wood					
Description	Block	SPEC	L (mm)	W (mm)	T (mm)
Comp. ID	A1,3S4	Finish Dim	69	24	24
Qty/unit	04	Raw Dim	89	34	29

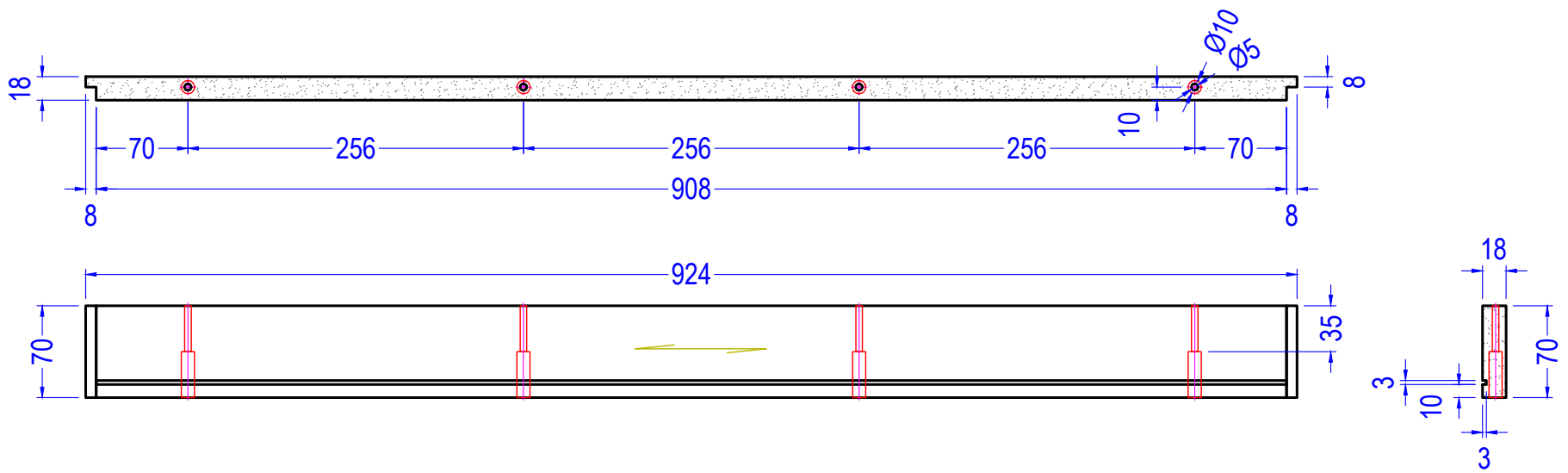

WoodFurniture

Item CODE:	PLP-1153	Description	Support side top 1	SPECIFICATIONS	L (mm)	W (mm)	T (mm)	Material:	MDF + Acacia veneer / local veneer
Item Name:	Dining table	Comp. ID	A1,2S3	Finish Dimension	924	70	18	Drawn by:	Mr. Antony Tran
Finish	---	Qty/unit	02	Raw Dimension	934	80	17	Drawn date:	November 16, 2021

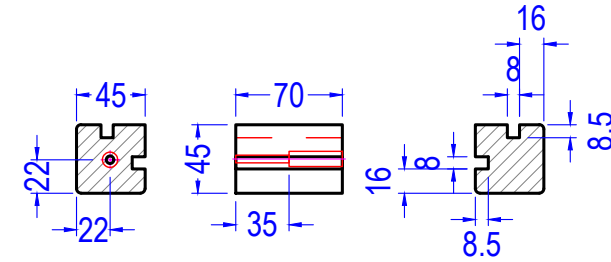
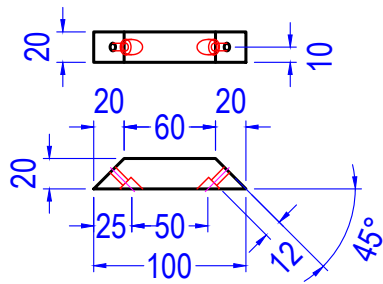

Material name:	Rubber wood				Material name:	Rubber wood					
Description	Cornet Block	SPEC	L (mm)	W (mm)	T (mm)	Description	Cornet side	SPEC	L (mm)	W (mm)	T (mm)
Comp. ID	A1,2S5	Finish Dim	100	20	20	Comp. ID	A1,2S6	Finish Dim	70	45	45
Qty/unit	016	Raw Dim	120	30	25	Qty/unit	04	Raw Dim	90	55	50

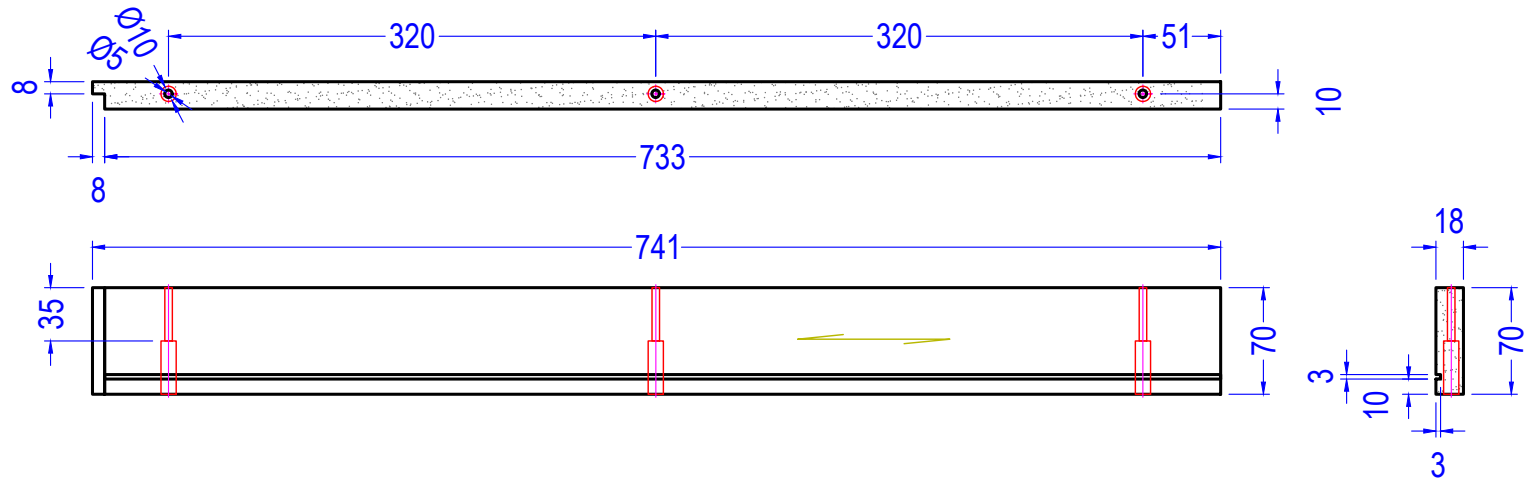

WoodFurniture	Item CODE:	PLP-1153	Description	Support side top 2	SPECIFICATIONS	L (mm)	W (mm)	T (mm)	Material:	MDF + Acacia veneer / local veneer	
	Item Name:	Dining table	Comp. ID	A2S2	Finish Dimension	741	70	18	Drawn by:	Mr. Antony Tran	
	Finish	---	Qty/unit	02	Raw Dimension	751	80	17	Drawn date:	November 16, 2021	Page: 11/13

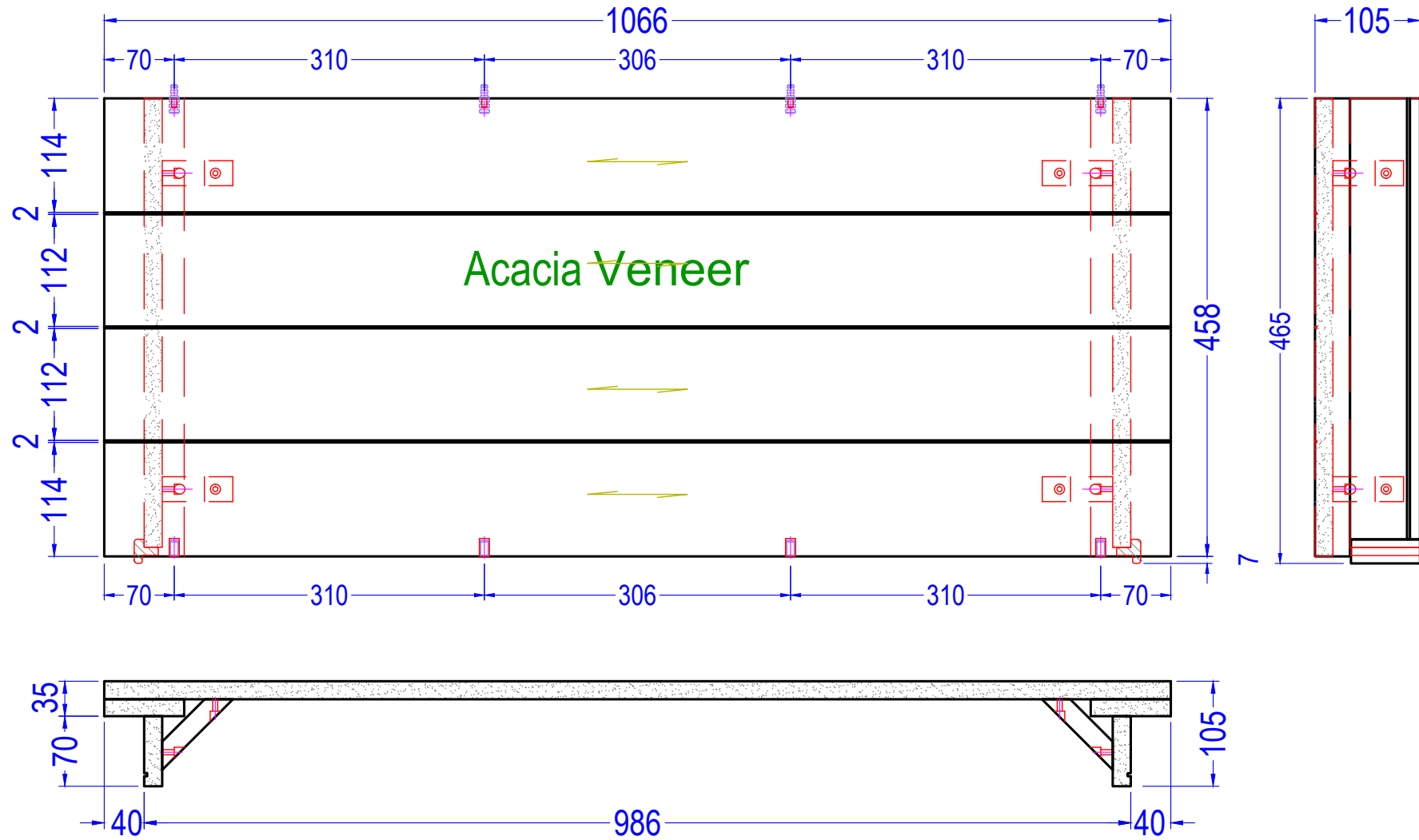

WoodFurniture	Item CODE:	D1977	Description	Leaf Top	SPECIFICATIONS	L (mm)	W (mm)	T (mm)	Material name:	...
	Item Name:	Dining table	Comp. ID	A3	Finish Dimension	465	1066	105	Drawn by:	Mr. Antony Tran
	Finish	---	Qty/unit	1					Drawn date:	November 16, 2021
										Page: 1/13

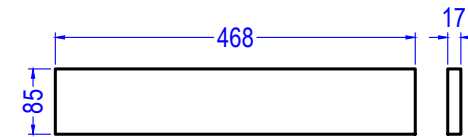
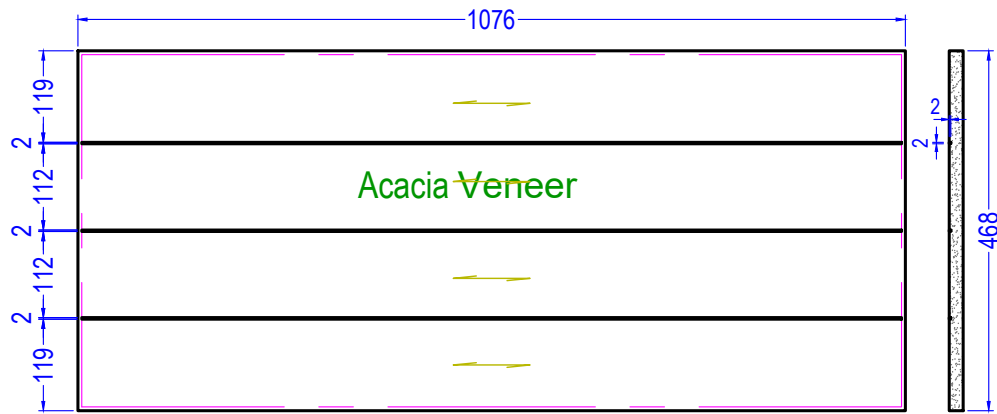

Description	Leaf Top panel	SPECIFICATIONS	L (mm)	W (mm)	T (mm)	Material name:
Comp. ID	A3S1F1	Finish Dimension	1076	468	18	MDF + Acacia veneer / local veneer
Qty/unit	01	Raw Dimension	1086	478	17	

Comp. ID	A3S1F2	Qty/unit	02	Description	Support top leaf	Material name:	MDF
----------	---------------	----------	-----------	-------------	------------------	----------------	-----

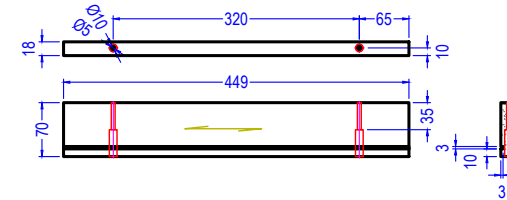
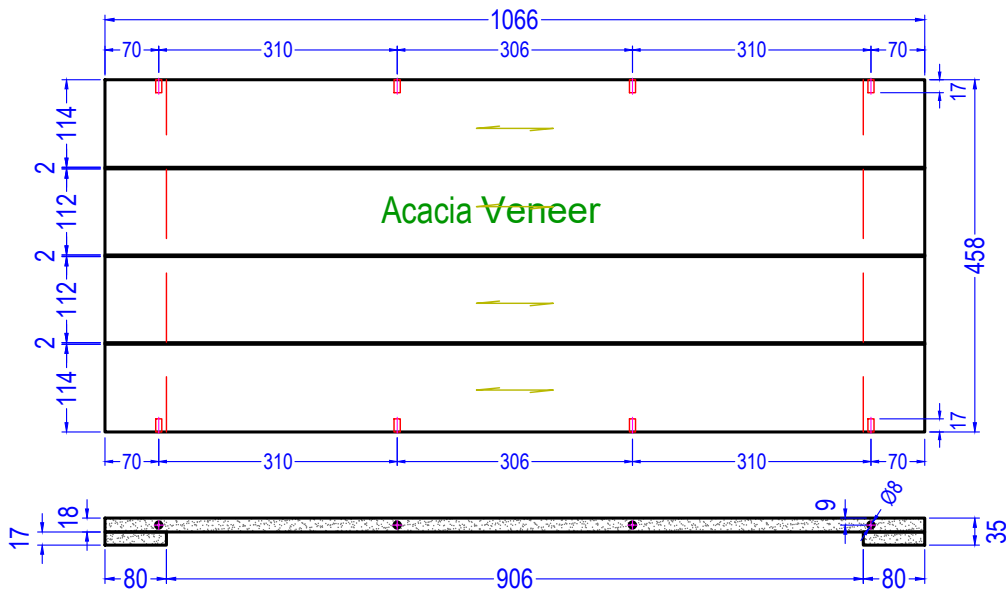

SPECIFICATIONS	L (mm)	W (mm)	T (mm)	Material name:	MDF + Acacia veneer / local veneer
Finish Dimension	458	1066	35	Drawn by:	Mr. Antony Tran
				Drawn date:	November 16, 2021

Page: 1/13

WoodFurniture	Item CODE:	PLP-1153	Description	Leaf Top frame	Description	Support side Leaf	SPECIFICATIONS	L (mm)	W (mm)	T (mm)	Material name:
	Item Name:	Dining table	Comp. ID	A3S1F	Comp. ID	A3S2	Finish Dimension	449	70	18	MDF + Acacia veneer / local veneer
	Finish	---	Qty/unit	01	Qty/unit	02	Raw Dimension	459	80	17	

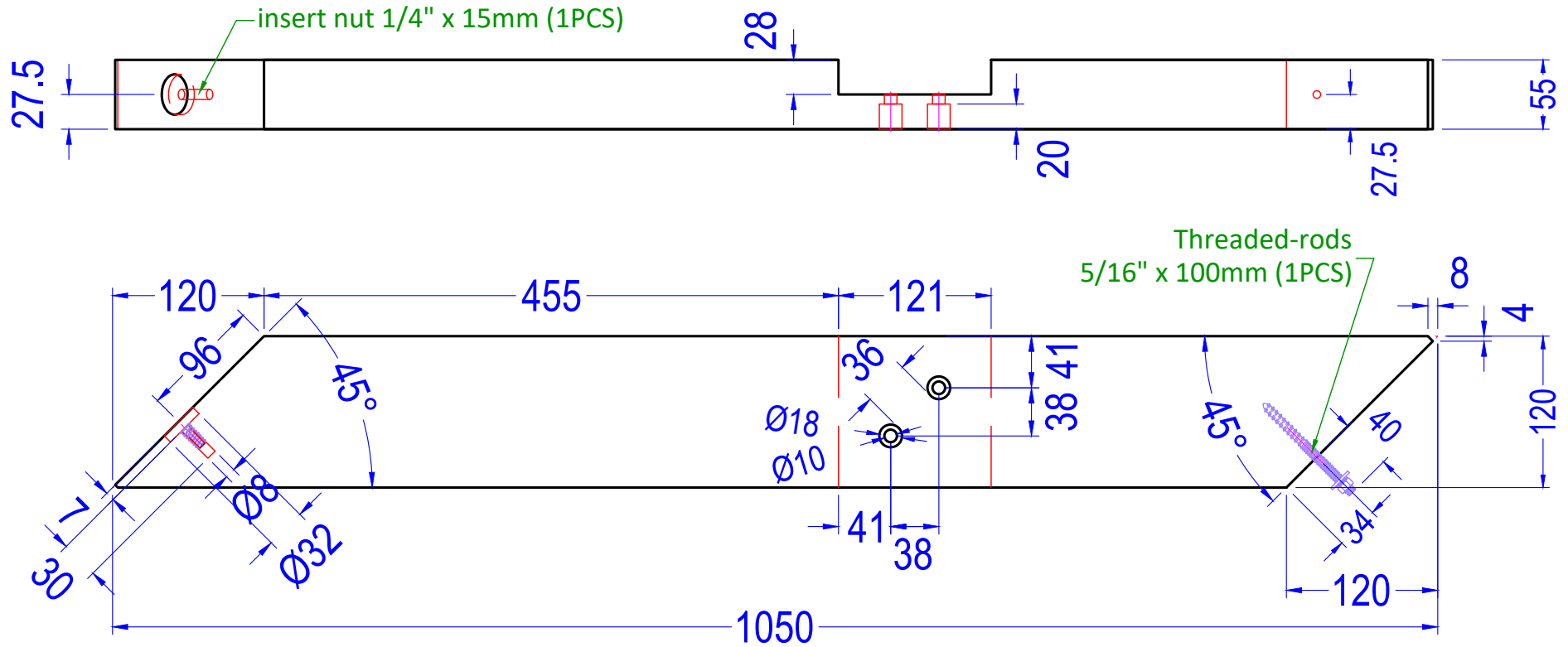

WoodFurniture	Item CODE:	PLP-1153	Description	Legs X 1	SPECIFICATIONS	L (mm)	W (mm)	T (mm)	Material name:	Rubber wood
	Item Name:	Dining table	Comp. ID	C1	Finish Dimension	1050	120	55	Drawn by:	Mr. Antony Tran
	Finish	---	Qty/unit	02	Raw Dimension	1070	130	60	Drawn date:	November 16, 2021

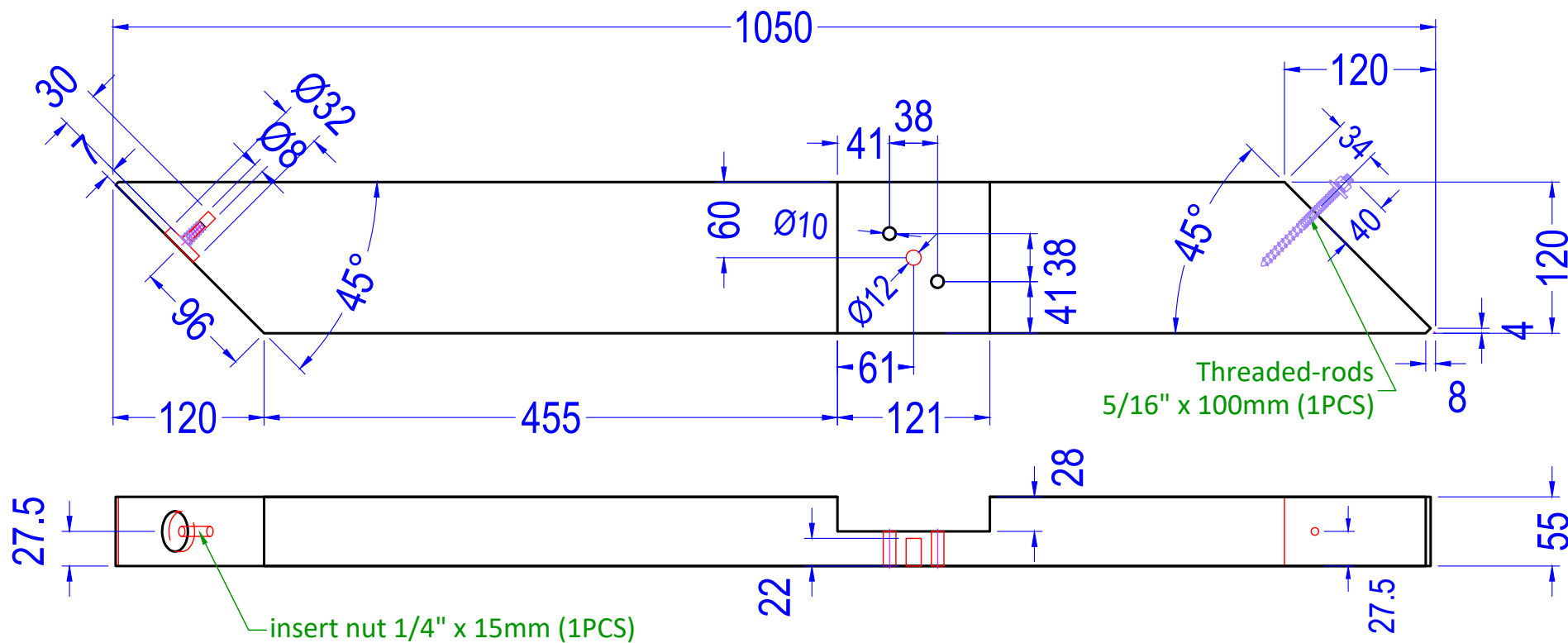

WoodFurniture	Item CODE:	PLP-1153	Description	Legs X 2	SPECIFICATIONS	L (mm)	W (mm)	T (mm)	Material name:	Rubber wood
	Item Name:	Dining table	Comp. ID	C2	Finish Dimension	1050	120	55	Drawn by:	Mr. Antony Tran
	Finish	---	Qty/unit	02	Raw Dimension	1070	130	60	Drawn date:	November 16, 2021

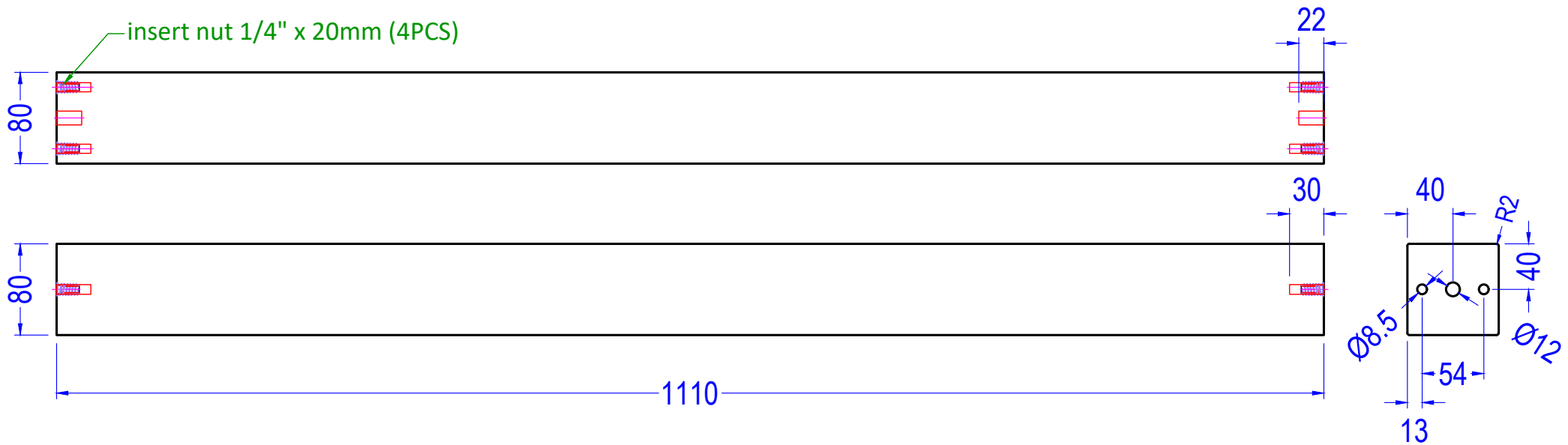

Item CODE:	PLP-1153	Description	Stretcher	SPECIFICATIONS	L (mm)	W (mm)	T (mm)	Material name:	Rubber wood
Item Name:	Dining table	Comp. ID	C3	Finish Dimension	1110	80	80	Drawn by:	Mr. Antony Tran
Finish	---	Qty/unit	01	Raw Dimension	1130	90	85	Drawn date:	November 16, 2021

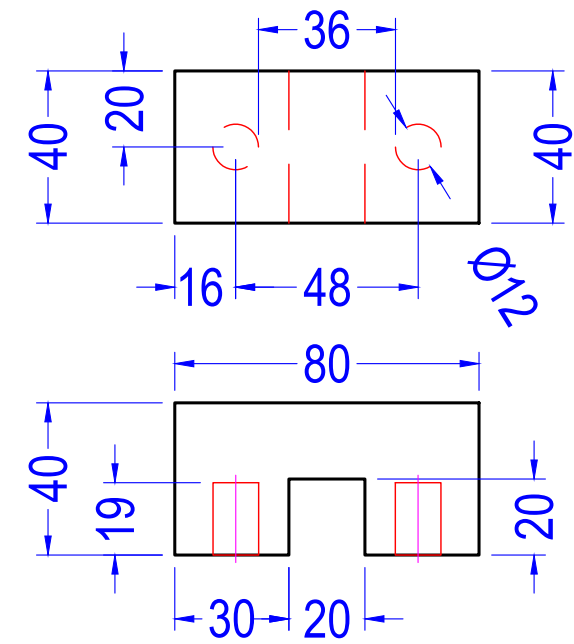
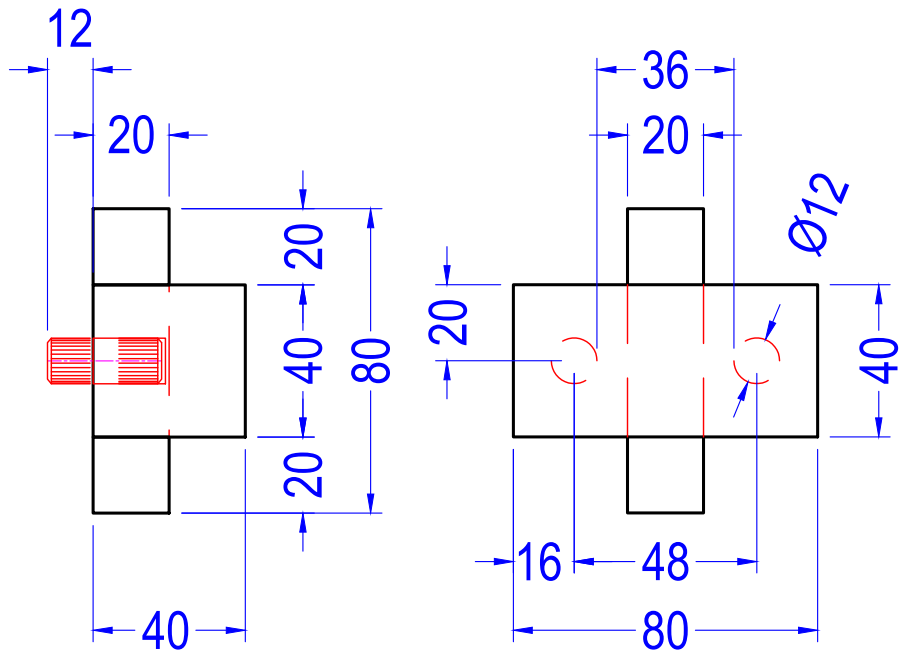

Material name:	Rubber wood				
Description	Block legs 1	SPEC	L (mm)	W (mm)	T (mm)
Comp. ID	C4F1	Finish Dim	80	40	40
Qty/unit	02	Raw Dim	100	50	45

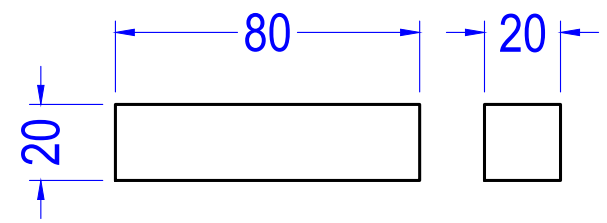

SPECIFICATIONS	L (mm)	W (mm)	T (mm)	Material name:	...
Finish Dimension	80	80	40	Drawn by:	Mr. Antony Tran
				Drawn date:	November 16, 2021
				Page:	1/13

Material name:	Rubber wood				
Description	Block legs 2	SPEC	L (mm)	W (mm)	T (mm)
Comp. ID	C4F2	Finish Dim	80	20	20
Qty/unit	02	Raw Dim	100	30	25

WoodFurniture	Item CODE:	D1977	Description	Block legs
	Item Name:	Dining table	Comp. ID	C4
	Finish	---	Qty/unit	2

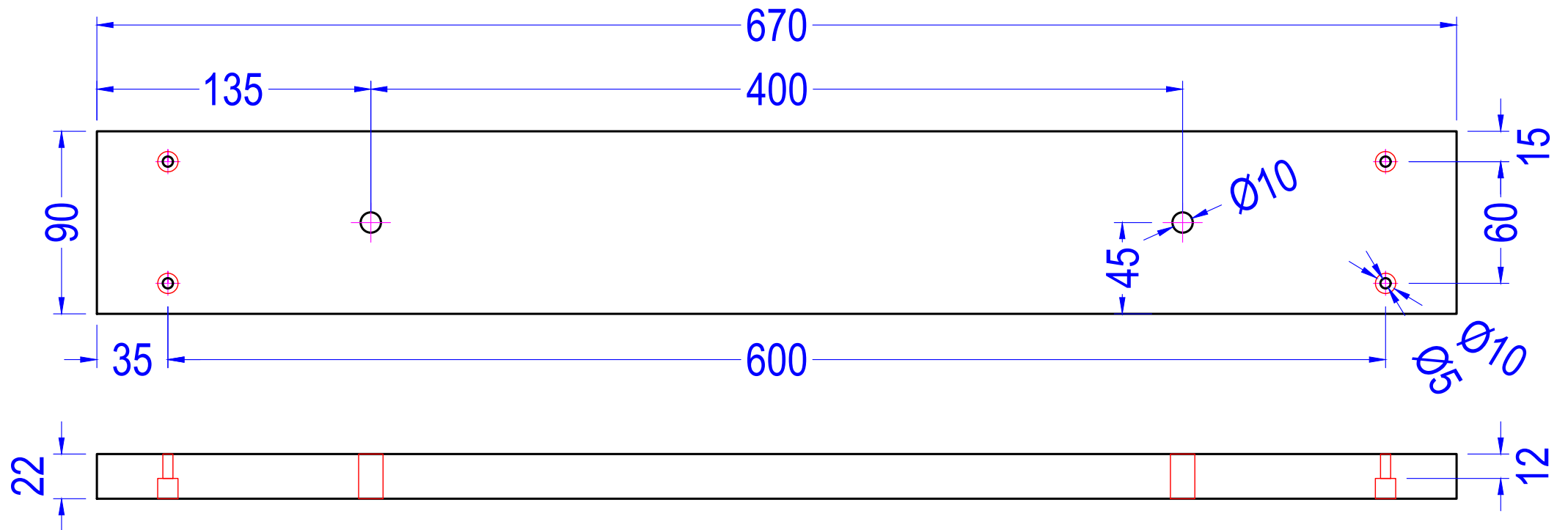

WoodFurniture	Item CODE:	PLP-1153	Description	Support Leg	SPECIFICATIONS	L (mm)	W (mm)	T (mm)	Material name:	Rubber wood
	Item Name:	Dining table	Comp. ID	C5	Finish Dimension	670	90	22	Drawn by:	Mr. Antony Tran
	Finish	---	Qty/unit	02	Raw Dimension	690	100	27	Drawn date:	November 16, 2021