

CREATIVE ARCHITECTS & ENGINEER'S
 Main southren baypass near DHA Main gate Khayban-e-Ali
 Bahwalpur

PROJECT:
 PROPOSED ELEVATION OF
 HOUSE COLONY
 BAHAWALPUR

DATE:

CLINT:

Covered Area:
 ----- sq.ft

REF:
 CHD-2213

DESIGN BY:
Asmara Batool
 0300-6118527

TITLE:
Ground Floor

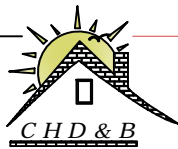
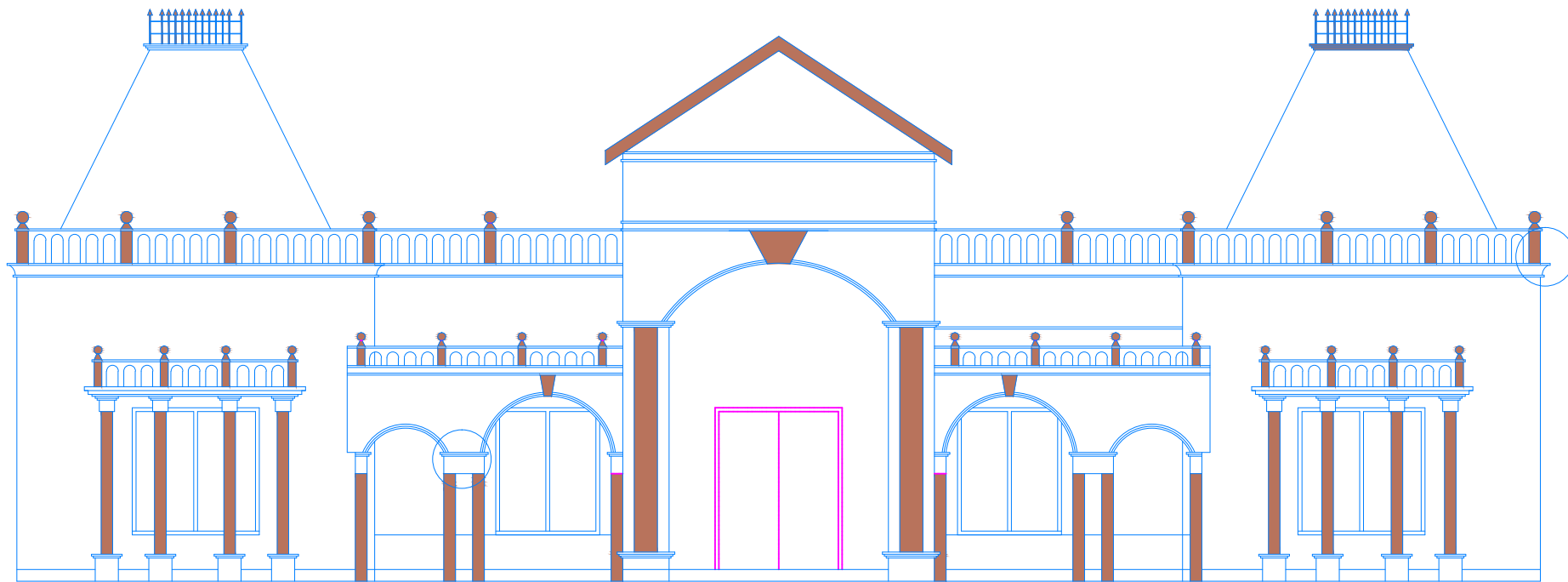

CREATIVE ARCHITECTS & ENGINEER'S
 Main southern bypass near DHA Main gate Khayban-e-Ali
 Bahawalpur

PROJECT:
 PROPOSED ELEVATION OF
 HOUSE COLONY
 BAHAWALPUR

DATE:

CLINT:

Covered Area:
 ----- sq.ft

REF:
 CHD-2213

DESIGN BY:
Asmara Batool
 0300-6118527

TITLE:
 Elevation

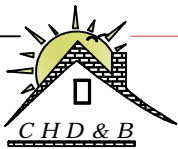
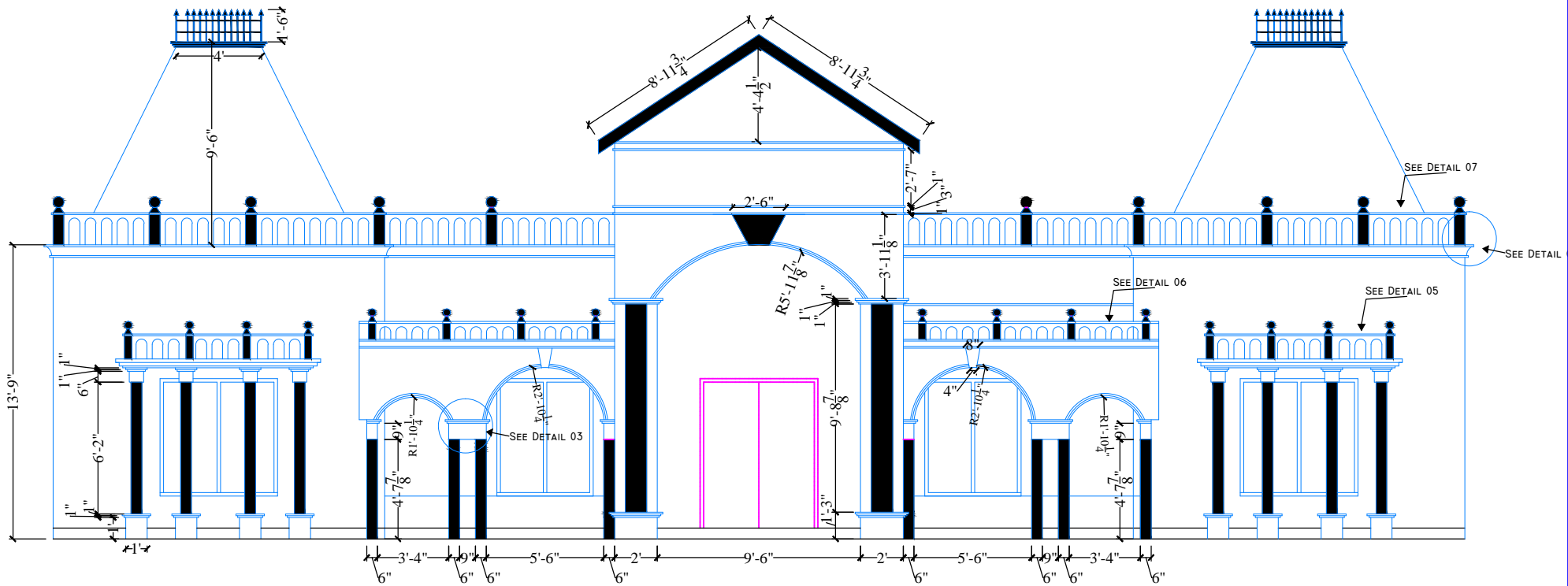

CREATIVE ARCHITECTS & ENGINEER'S
 Main southern baypass near DHA Main gate Khayban-e-Ali
 Bahawalpur

PROJECT:
 PROPOSED ELEVATION OF
 HOUSE COLONY
 BAHAWALPUR

DATE:

CLINT:

Covered Area:
 ----- sq.ft

REF:
 CHD-2213

DESIGN BY:
 ASMARA BATOOL
 0300-6118527

TITLE:
 Elevation
 Details

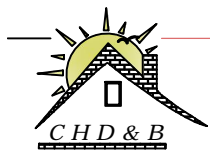
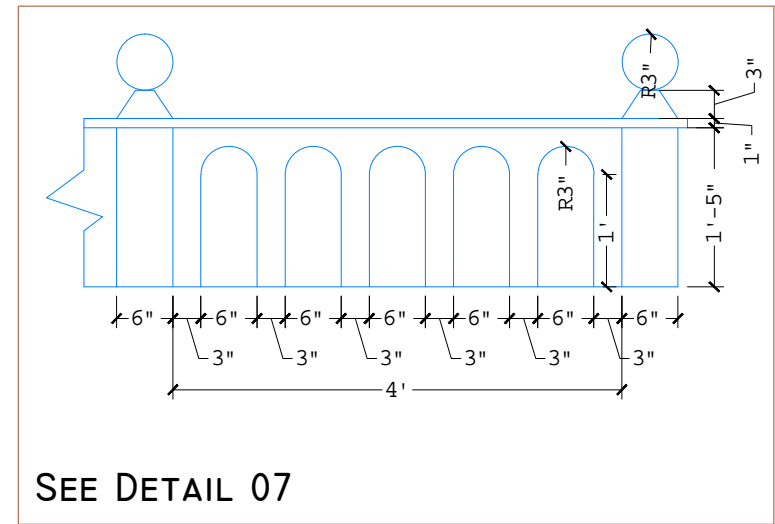
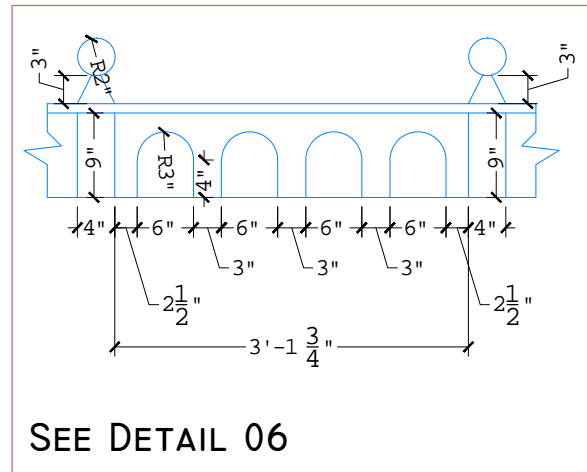
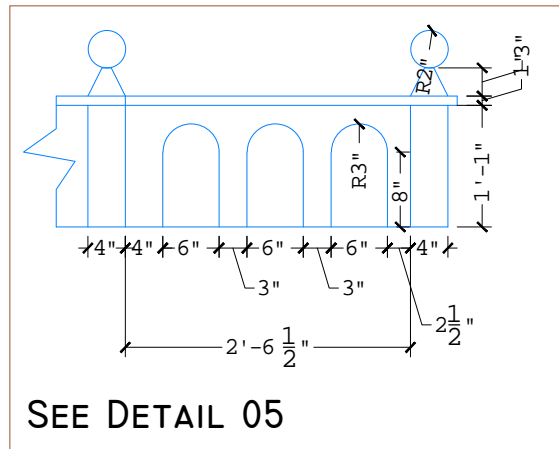
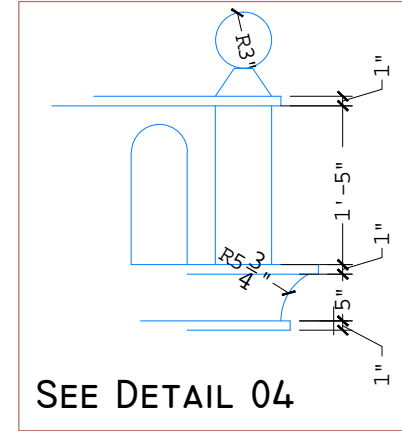
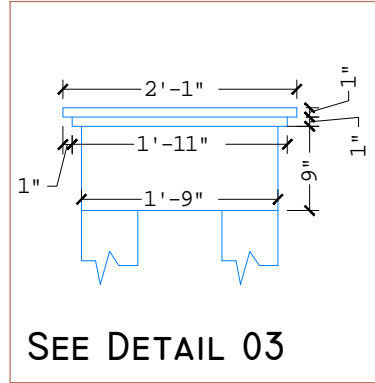
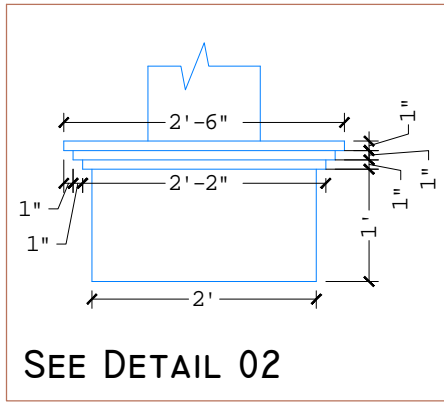
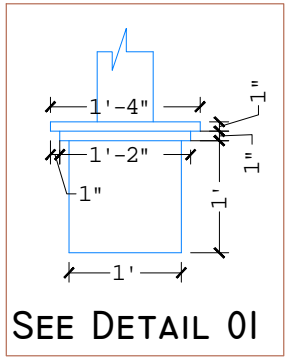

CREATIVE ARCHITECTS & ENGINEER'S
Main southern bypass near DHA Main gate Khayban-e-Ali
Bahawalpur

PROJECT:
PROPOSED ELEVATION OF
HOUSE COLONY
BAHAWALPUR

DATE:

CLINT:

Covered Area:
----- sq.ft
REF:
CHD-2213

DESIGN BY:
Asmara Batool
0300-6118527

TITLE:
**Ground Floor
Details**